

# Vertical Sealless Pump

YD – VK3, YD – VP3 series

# DRYFREE

Instruction manual (TOSHIBA MOTOR)

Version: 171207

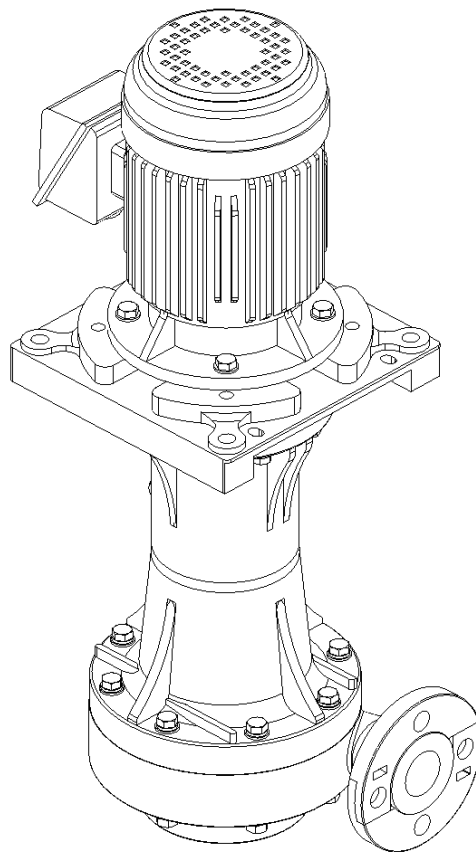

**World Chemical Co., Ltd.**

## PREFACE

Thank you very much for purchasing World Chemical’s vertical sealless pump “DRYFREE”.

DRYFREE is constructed of corrosion resistant materials like CFR PP (Carbon fiber reinforced polypropylene), and is both time saving and user friendly. An adequate understanding of this manual is required to maximize the pump’s performance and to assure safety and long-term efficiency. Store this manual where it can be easily accessed.

## TABLE OF CONTENTS

■ <b>INSPECTION WHEN UNPACKING</b> .....	1
■ <b>SAFETY PRECAUTION (To be observed at all times)</b> .....	1
■ <b>MODEL DESCRIPTION/STANDARD PERFORMANCE</b> .....	4
■ <b>OUTLINE DIMENSION</b> .....	5
■ <b>CAUTION WHEN INSTALLING, LAYING PIPES</b> .....	8
■ <b>CAUTION WHEN OPERATING</b> .....	10
■ <b>TROUBLESHOOTING</b> .....	11
■ <b>MAINTENANCE</b> .....	12
■ <b>DISMANTLING AND ASSEMBLING</b> .....	13
■ <b>EXPLODED VIEW</b> .....	15
■ <b>WARRANTY / REPAIR</b> .....	16

### ■ **INSPECTION WHEN UNPACKING**



Please examine the product before use.



- (1) Check the name plate that the product specification matches your order and accessories.
- (2) Check that the product has not been accidentally damaged during transport.
- (3) If the usage is changed from the time you ordered, should be contact us.

### ■ **SAFETY PRECAUTION (To be observed at all times)**

The following procedures are intended to protect you from personal injury and/or property damage.









- The following symbols classify the degree of danger and explain the damages that could occur when its contents are ignored or the pump is used improperly.
- Safety rules to be observed are classified and explained under the following symbols. (The following are examples of picture displays).

	Non-compliance can lead to fatal or serious injury.
<b>Warning</b>	
	Non-compliance can lead to some injury and/or property damage.
<b>Caution</b>	

	This symbol cautions people to be careful.
	This symbol signifies that this action must not be taken.
	This symbol indicates that the action must be taken.











## WARNING

-  (1) Dangerous liquid, and surroundings.  
When using the pump to transfer dangerous liquids or in surroundings (only explosion prevention specifications). Observe the facility standards determined by law and daily check to prevent leakage. If the pump is operated under abnormal conditions like liquid leakage, it may cause serious accident such as personal injury, explosion or fire. Follow the maker's instructions for handling chemical liquid.
-  (2) Prohibit from using damaged or modified pumps.  
Using damaged or modified pumps may lead to personal injury, electric shock or the pump damage. It is not covered by our warranty.
-  (3) Caution about carrying or lifting pumps.  
Use the hoist bolt when the pump has it. If not, lift it by using a belt sling with careful attention of the weight balance. This operation is performed by qualified personnel and use the slings enough strong. Even the pump is the lightest one, the weight is around 28kg. Do not carry pumps by hand, because it may lead to accident.
-  (4) Prohibit from operating with the power on.  
Do not check the pump / motor or dismantle with the power on. It leads to personal injuries from electric shock or from getting caught in the rotor. Take multiple safety measures such as a hand switch other than the main power or operation switch.
-  (5) Connecting earth cable.  
Using the pump without an earth cable with the motor may cause electric shock. Connect it by qualified person in accordance with electric facilities technical standards and interior wiring regulations.
-  (6) Protecting the power supply cord.  
Stretching, pinching or breaking the power supply cords or motor lead wires causes fire or electric shock, because of the cable damaged. After wiring, set the terminal box at the right position.
-  (7) Installing Ground Fault Interrupter (GFI)  
Electric shock may be occurred if the pump is used without attaching ground fault interrupter device. Install a circuit breakers or over-current protection device to prevent electric accidents or the pump damages.
-  (8) Caution when removing pumps  
When removing the pump from piping, make sure to close the suction and discharge pipe valves and check no liquid leakage. Touching chemical liquid directly may cause to be harmful, so wear protective gear when working.



## CAUTION

-  (1) Prohibit from unapplied use.  
Do not use the pump for purposes other than those specified on the nameplate. Check the motor (phase, voltage and frequency) prior, then, wire the motor. If wrong use, it may cause personal injuries or the pump and peripheral equipment damaged.
-  (2) Restrictions on handler.  
Carry, install, wire, operate and maintain the pump by experts who have full knowledge of the pump.
-  (3) Caution when unpacking.  
Unpack after checking the up and down of the packing. When unpacking a wooden crate/box, be careful to avoid injury from nails and silvers.
-  (4) Ventilation.  
Do not obstruct ventilation of the pump to prevent the motor overheat. If handling toxic or odorous liquids, install the pump in a well-ventilation to prevent poisoning.
-  (5) Repairs and returning.  
When returning the damaged pump, contact your supplier or us. If the pump is to be returned for repairs by couriers, wash it thoroughly, check no adhered liquid and wrap it with plastic bag.
-  (6) Resin parts.  
The pump is made of resin and may cause personal injuries for the damage by strong impact. Do not hit the pump against any objects or get it on.  
Moreover, place piping supports to prevent the piping load.
-  (7) At the start of the pump.  
Check the rotation direction when starting the pump at the beginning. On this occasion, open the suction and discharge valves and check no liquid leakage at the pipe connection. Check the rotation direction by turning on the switch instantly after removing air in the piping and fill liquid inside. If the rotation reversed, switch two of the three phases in the three phase power supply to change the direction of rotation. It is sure to turn off the power and confirm safety before switching the two phases.
-  (8) Disposing pumps.  
When disposing used pumps, remove the adhered liquid and discard as industrial waste in accordance with the law.
-  (9) Leak protection.  
Take appropriate preventative measures to safeguard against liquid leakage in the event of a breakdown of the pump or piping.

■ **MODEL DESCRIPTION**

Ex. **YD – 41 01 VK3 – CP – D – E 5 1 – □**  
 (1) (2) (3) (4) (5) (6) (7) (8) (9)

- (1) Discharge bore : 40=40A 50=50A 65=65A
- (2) Motor output : 01=1HP/0.75kW , 02=2HP/1.5kW, 05=5HP/3.7kW, 07=7HP/5.5kW, 10=10HP/7.5kW
- (3) Model : VK3=S.G.1.1 VP3=S.G.1.4
- (4) Material : CP=CFR PP
- (5) Seal type : D=with Dry seal, K=with Cut seal, W=with Dry seal & Cut seal
- (6) O-ring material : E=EPDM D=FPM P=PTFE
- (7) Frequency : 5=50Hz 6=60Hz
- (8) Specific gravity : 1=1.1 4=1.4
- (9) Special : V=Non-standard motor, M=TOSHIBA long shaft motor, J=Joint type, Z=Non-standard material

- VK3 S.G.1.1 In-tank is available and circulating liquid in a scrubber is suitable.
- VP3 S.G.1.4 For high pressure and used for etching to make Print Circuit Board.

● Use

1. Spray for etching.
2. Circulation in a scrubber.
3. Circulation in a reaction/mixing tank.
4. Electroless nickel plating liquid, standard plating liquid or heat exchanger.
5. Liquid exchange

- The temperature range of used liquid From 0 to 70 degrees

- Material CFR PP (Carbon fiber reinforced polypropylene)

● Features

1. Good at heat and corrosion resistance and used for wide variety of liquid for corrosion resistant resin.
2. The special impeller for air suction as less as possible.
3. No heat/abrasion trouble for sealless structure. Small amount of slurry is fine.
4. Molding parts are assembled with accuracy and efficiency.
5. Cut seal is adopted as standard against temporary liquid leakage by backflow. (Except 400\*VK3)

■ **STANDARD PERFORMANCE**

**VK3** 50Hz: S.G.1.1

Model	Bore (mm)		Output		Total head m	Capacity L/min	Weight kg
	Suc.	Dis.	HP	kW			
YD-4001VK3-CP-D 51	50	40	1	0.75	9	150	28
YD-4002VK3-CP-D 51	50	40	2	1.5	10	300	28
YD-5003VK3-CP-W 51	65	50	3	2.2	12	350	33
YD-6505VK3-CP-W 51	80	65	5	3.7	15	550	47
YD-6507VK3-CP-W 51	80	65	7.5	5.5	18	700	74

Model	Bore (mm)		Output		Total head	Capacity	Weight
	Suc.	Dis.	HP	kW	m	L/min	kg
YD-4001VK3-CP-D 61	50	40	1	0.75	8	120	28
YD-4002VK3-CP-D 61	50	40	2	1.5	8	300	28
YD-4003VK3-CP-D 61	50	40	3	2.2	12	350	31
YD-5005VK3-CP-W 61	65	50	5	3.7	15	550	46
YD-6507VK3-CP-W 61	80	65	7.5	5.5	18	700	74
YD-6510VK3-CP-W 61	80	65	10	7.5	25	850	77

## VP3

50Hz: S.G.1.4

Model	Bore (mm)		Output		Total head	Capacity	Weight
	Suc.	Dis.	HP	kW	m	L/min	kg
YD-5003VP3-CP-W 54	65	50	3	2.2	12	300	33
YD-5005VP3-CP-W 54	65	50	5	3.7	15	430	46
YD-6507VP3-CP-W 54	80	65	7.5	5.5	17	600	74
YD-6510VP3-CP-W 54	80	65	10	7.5	18	750	77

60Hz: S.G.1.4

Model	Bore (mm)		Output		Total head	Capacity	Weight
	Suc.	Dis.	HP	kW	m	L/min	kg
YD-5003VP3-CP-W 64	65	50	3	2.2	11	300	33
YD-5005VP3-CP-W 64	65	50	5	3.7	15	430	46
YD-6507VP3-CP-W 64	80	65	7.5	5.5	22	400	74
YD-6510VP3-CP-W 64	80	65	10	7.5	20	750	77

## OUTLINE DIMENSION

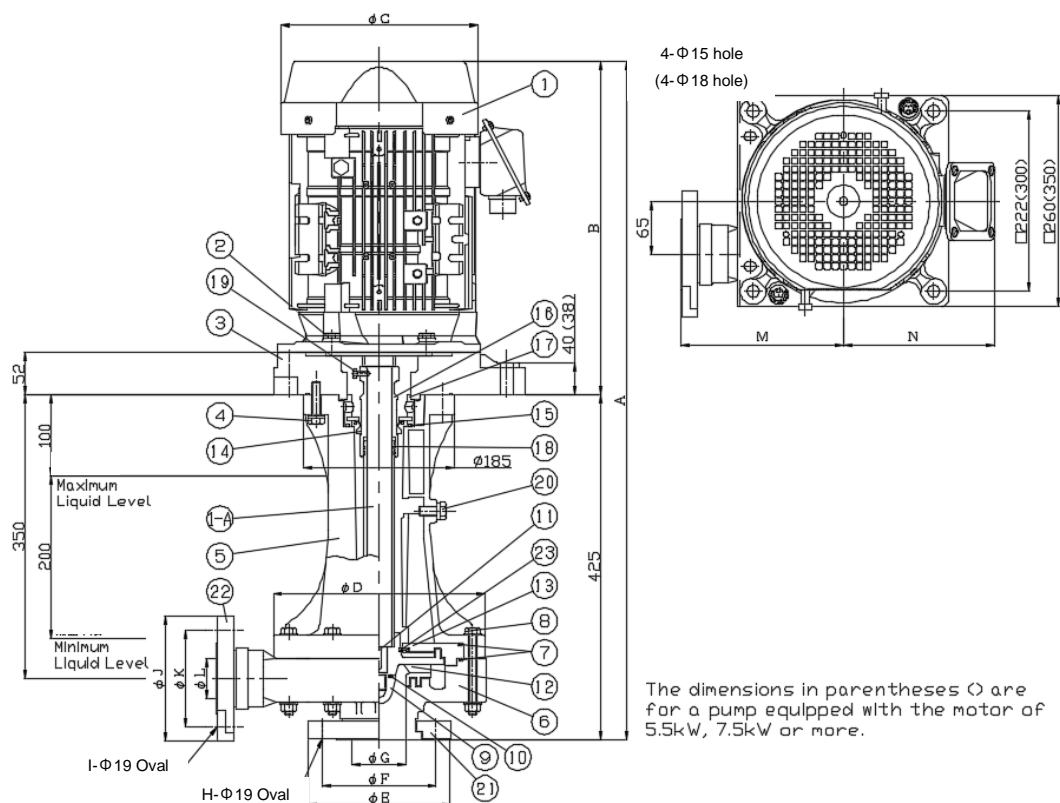

□ Parts list

No.	PARTNAME	MATERIAL	QTY
1	Motor		1
1-A	Shaft	SUS304	1
2	Hexagon head bolt	SUS304/Titanium	4
3	Base	GFRPP	1
4	Hexagon head bolt	SUS304/Titanium	8
5	Connecting pipe	CFRPP	1
6	Casing	CFRPP	1
7	O-ring	EPDM/FPM	2
8	Hexagon head bolt, nut	SUS304/Titanium	8
9	Impeller nut	CFRPP	1
10	O-ring	EPDM/FPM	1
11	Shaft key	SUS316	1
12	Impeller	CFRPP・C3604B	1
13	Back plate	CFRPP/PP	1
14	Dry seal	FPM	1
15	O-ring	EPDM/FPM	1
16	Dry seal holder	GFRPP・SUS304	1
17	Seal case	GFRPP・Ceramics	1
18	O-ring	EPDM/FPM	2
19	Hexagon head bolt	SUS304	1
20	Hexagon head bolt	PVC	1
21	Split flange	CFRPP	2
22	Split flange	CFRPP	2
23	Cut seal	FPM	1

\*1: No.16, 18 and 19 are not attached with the pump with motor 5(5.5kW and more).

\*2: No.23 "Cut seal" is not attached with the high temperature type.

\*3: No.23 "Cut seal" is not attached with YD-400□VK3.

\*4: The material of Back plate of YD-4001VK3-CP-D 61 & YD-5003VP3-CP-W 64 is PP.

\*5: The dimension & parts list of the joint type pump are different. Refer to the drawings

□ Dimension

**VK3**

50Hz: S.G.1.1

Model	Bore (mm)		Output (kW)	A	B	φ C	φ D	φ E	φ F	φ G	H	I	φ J	φ K	φ L	M	N
YD-4001VK3-CP-D 51	50	40	0.75	760	305	170	230	155	120	58	4	4	145	105	42	170	152
YD-4002VK3-CP-D 51	50	40	1.5	789	364	22	230	155	120	58	4	4	145	105	42	170	168
YD-5003VK3-CP-W 51	65	50	2.2	789	364	202	260	175	140	66	4	4	155	120	50	200	168
YD-6505VK3-CP-W 51	80	65	3.7	836	411	243	260	190	150	78	8	4	175	140	63	200	187
YD-6507VK3-CP-W 51	80	65	5.5	874	449	285	260	190	150	78	8	4	175	140	63	200	263

60Hz: S.G.1.1

Model	Bore (mm)		Output (kW)	A	B	φ C	φ D	φ E	φ F	φ G	H	I	φ J	φ K	φ L	M	N
YD-4001VK3-CP-D 61	50	40	0.75	760	335	170	230	155	120	58	4	4	145	105	42	170	152
YD-4002VK3-CP-D 61	50	40	1.5	789	364	202	230	155	120	58	4	4	145	105	42	170	168
YD-4003VK3-CP-D 61	50	40	2.2	789	364	202	230	155	120	58	4	4	145	105	42	170	168
YD-5005VK3-CP-W 61	65	50	3.7	836	411	243	260	175	140	66	4	4	155	120	50	200	187
YD-6507VK3-CP-W 61	80	65	5.5	874	449	285	260	190	150	78	8	4	175	140	63	200	263
YD-6510VK3-CP-W 61	80	65	7.5	874	449	285	260	190	150	78	8	4	175	140	63	200	263

**VP**

50Hz: S.G.1.4

Model	Bore (mm)		Output (kW)	A	B	φ C	φ D	φ E	φ F	φ G	H	I	φ J	φ K	φ L	M	N
YD-5003VP3-CP-W 54	65	50	2.2	789	364	202.0	260	175	140	66	4	4	155	120	50	200	153
YD-5005VP3-CP-W 54	65	50	3.7	836	411	243	260	175	140	66	4	4	155	120	50	200	184
YD-6507VP3-CP-W 54	80	65	5.5	874	449	285	260	190	150	78	8	4	175	140	63	200	203
YD-6510VP3-CP-W 54	80	65	7.5	874	449	285	260	190	150	78	8	4	175	140	63	200	203

60Hz: S.G.1.4

Model	Bore (mm)		Output (kW)	A	B	φ C	φ D	φ E	φ F	φ G	H	I	φ J	φ K	φ L	M	N
YD-5003VP3-CP-W 64	65	50	2.2	789	364	202	260	175	140	66	4	4	155	120	50	200	153
YD-5005VP3-CP-W 64	65	50	3.7	836	411	243	260	175	140	66	4	4	155	120	50	200	184
YD-6507VP3-CP-W 64	80	65	5.5	874	449	285	260	190	150	78	8	4	175	140	63	200	203
YD-6510VP3-CP-W 64	80	65	7.5	874	449	285	260	190	150	78	8	4	175	140	63	200	203



## ■ CAUTION WHEN INSTALLING, LAYING PIPES

### 1. Installation height and liquid level in a suction tank

The pump does not have a fixed sliding type seal such as mechanical seals or gland packing. Regarding the installation height, refer to the below picture.

The standard liquid level of a suction tank is from the upper level to the lower level, but when the pump is set at the upper level, the liquid rises to the top of the pump and it may cause liquid leakage at the pump stop or re-start according to the piping or the condition of the attendant equipment.

If there is an attendant equipment at the discharge outlet such as a filter which has liquid pools, install a check valve between the pump and piping to prevent backflow.

### Examples of Standard Installation

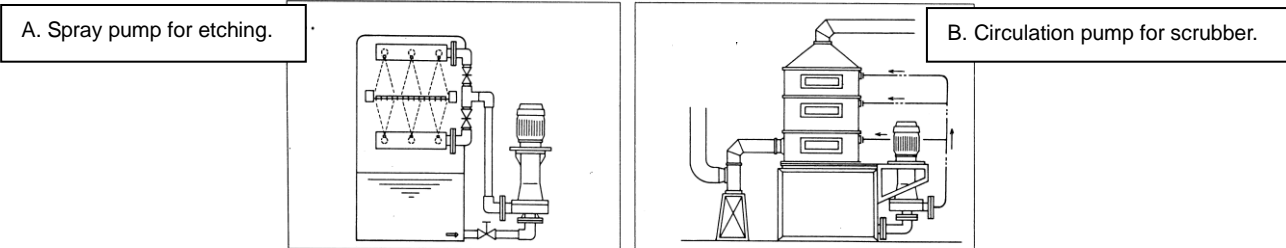
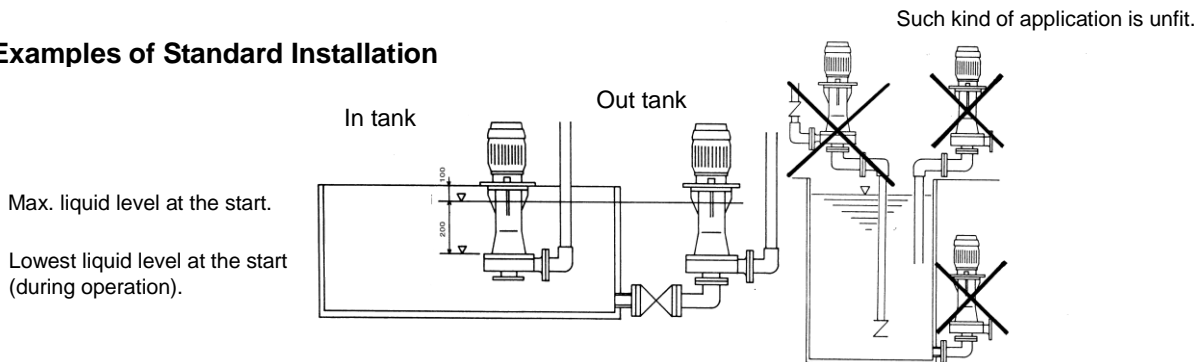

### 2. Caution about the operation which is unconfirmed joint and seal parts

When operating the pump for the first time after installation or re-assembly, check primed water inside and air released. Also, make sure to check the condition of seals of that pump and suction/discharge connection. Operate the pump without liquid leakage and air suction.

### 3. Installation position and placement

- The Installation position is as near as the suction tank, and set the liquid level in the standard range. (Suction flooded). It is possible to use the pump outdoors, not only indoors (Indoor type pump is indoor only), but take safety measures not to badly affect the motor or wire at the emergency such as flooded.
- Anchor the pump vertically on level surface where there is no influence of other machine's vibration. Take a sufficient space around the pump for easy access for maintenance and the motor cooling fan. Ensure to fix the pump mount not to occur vibration.

#### 4. Piping

- For the connection of suction/discharge flanges, use M16 bolt and tighten them evenly with an appropriate torque. M16 bolt: Recommended torque: 19.6N·m (200kgf·cm)  
The flange is split type and start to tighten from the bolt on the matching face evenly.

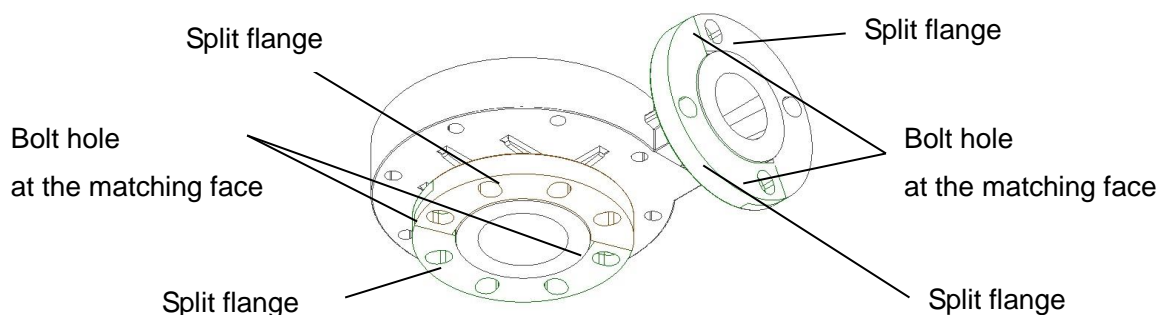

- Employ the flooded suction method at the suction inlet and shorten the pipe with less bending. Place piping supports not to apply the piping load and thermal stress.
- Do not allow spaces where air stays. It causes air lock (Dry running).
- When transferring high-temperature liquid, saturated steam pressure rises and the suction ability is decreased. To prevent cavitation, use pipes with one size larger diameter or shorten the pipe with as less bending as possible.
- Place piping supports not to apply load of discharge pipe to the pump.
- When placing a screen such as a strainer at the suction inlet, periodically clean it. Clogging makes the pump ability and performance decreased.
- If the piping is long, the specified performance may not obtained by increased piping resistance. Determine the pipe diameter by calculating it.
- Install valves that induce less pressure loss on the suction/discharge pipes with consideration for maintenance and accessibility.

#### 5. Wiring



Handle electrical wiring and power source setup by only qualified people. When personal injury and equipment damage occur against the advice, we accept no responsibility. If necessary, consult with your supplier or us. For wiring, abide by the local and national electrical codes.

- Use an electromagnetic switch that conforms to the specifications of the pump motor (voltage, watt, etc.).
- When using the pump outdoors, wire and set the switches without rainwater and moisture.
- Install the electromagnetic switch and push button at a reasonable distance from the pump.

## ■ CAUTION WHEN OPERATING

### 1. General cautions



- Do not operate the pump with the suction valve closed, because the pump may be damaged by a rapid vacuum state of the pump.
- In the event of cavitation, stop the pump immediately and do not operate the pump with air trapped.
- IF the pump is operated with closed, the temperature of the pump inside rises and it causes the pump failure.
- Turn off the power switch immediately when power outage occurs in operation.
- When transferring high-temperature liquid, the pump surface becomes very hot, so install a protection device to prevent burn injury.

### 2. Before the operation

When operating the pump for the first time after installation or after long-term suspension, prepare for operation as described below.

- Add liquid after cleaning the inside of the pipe and the tank.
- Check no loosened flange bolt or base bolt and re-tighten them.
- Add priming liquid into the pump and release air in the pump and piping.
- Run the motor momentarily to check the direction of motor's rotation after adding priming liquid into the pump (or after checking the pump filled with liquid). The rotation direction is clockwise as viewed from the motor fan. Follow the arrow on the motor casing. If the motor rotates in reverse, stop the pump immediately and switch two wires of the three-phase power wires after the power off.

### 3. Operation

Check the valves open/close after the preparation. When the operation starts continuously, check that the flow rate and pressure are appropriate specified points.

### 4. When stopping operation



When turn off the power, the pump stops slowly. If it is not smooth, check the inside of the pump.

In case of long-term suspension of operation, withdraw inside liquid from the pump, wash inside and close the suction/discharge valves.

## ■ TROUBLESHOOTING

If the failure cause is unknown, stop the operation immediately and contact your supplier.

Problem	Sympton on pump		Cause	Check & Measures
	When the discharge valve is closed.	When the discharge valve is opened.		
No pumping		The pressure gauge & vacuum gauge indicate zero.	● Insufficient priming water.	○ Stop the pump, fill with priming liquid and re-start it.
	Priming water does not go into the pump.		● The strainer is clogged. ● Improper suction piping. ● The liquid level in suction tank is declined.	○ Clean the strainer. ○ Check no clogged pipes. ○ Adjust the liquid level.
	When the discharge valve is opened at the start of the operation, the pressure is decreased.	The reading of the pressure and vacuum gauge shakes and drops to zero.	● Air enters through suction pipe or gaskets.	○ Check the suction flange is sealed. ○ Check the abnormal lowering of the suction liquid level. ○ Check the voltage is normal.
	Pumping failure when re-starting the pump after suspension.	No pumping when re-starting the pump after suspension.	● Air lock. Air accumulation in the suction pipe.	○ Release air in pipes. ○ Check pips and modify air pocket section. ○ Back flow liquid enters at the pump stoppage. Adjust pipes to exhaust air to the suction tank / clean the strainer not to clog.
	The pressure gauge readings remain low at all time.		● Pump rotation failure. ● Pump rotation in reverse.	○ Check wiring and the motor. ○ Switch wiring.
Dischrge quantity is not enough.		The reading of the vacuum gauge is high.	● The strainer and the suction pipe are clogged.	○ Clean the striner and remove foreign objects.
	The reading of the pressure gauge and vacuum gauge is normal.	Vibration occurs.	● The impeller is clogged.	○ Remove foreign objects.
		The reading of the pressure and vacuum gauge fluctuates.	● Air enters from the suction pipe or gasket.	○ check the joints of the suction pipe and re-tighten.
			● The discharge outlet is clogged.	○ Remove foreign objects inside the pump and scales in the pipe.
		The reading of the pressure gauge is high, but the vacuum gauge is normal.	● There is resistance in the discharge pipe / Actual head or coefficient of loss is high.	○ Check the actual pump head and conefficient of loss in the discharge pipe and take measures.
The reading of the pressure gauge and vacuum gauge is low.	The reading of the pressure gauge and and vacuum gauge is low.	● Reverse rotation	○ Switch wiring.	
Motor heats up			● The voltage decreases. ● Overload. ● The ambient temperature is high.	○ Check the voltage and frequency. ○ Ccheck the flow rate, liquid specific gravity and viscosity. ○ Well-ventilation.
Sudden loss of discharge quantity		The reading of the vacuum gauge is high.	● The strainer is clogged.	○ Remove foreign objects.
			● Base defect. ● Bolts are loosened. ● The suction pipe is clogged / Cavitation occurs. ● The impeller comes into contact with the casing. ● The motor and bearing are worn.	○ Re-install the pump. ○ Re-tighten bolts. ○ Clean and remove the cause for cavitation. ○ Remove the cause or replace the parts. ○ Replace the motor or bearing.

## ■ MAINTENANCE

### ◆ Daily check

- Check for no liquid leakage before operation. If any, stop the operation and take measures.
- Check that pump works smoothly without abnormal noise or vibration.
- Check for the liquid level in the tank and the suction pressure.
- Compare the flow rate, discharge pressure and current value during operation to those values indicated on the nameplate, and check that pump load is normal.

**Note:** The indication of the pressure gauge is proportionate to the specific gravity of the liquid.

- If spare pumps are available, keep it ready for use by operating it from time to time.
- Check that the discharge pressure, flow rate and motor current/voltage during operation is fluctuated. If they fluctuate greatly, see *Troubleshooting* and take proper actions.

### ◆ Periodical check

To use the pump smoothly, carry out the periodical check as follows. When an overhaul, handle carefully not to scratch seal parts.

Check term	Parts name	Check points	Measures
Once 12 months or Once 1,000 hours  *Leave the check records.	Motor	<ul style="list-style-type: none"> <li>● Sound of bearing during operation.</li> <li>● Vibration.</li> <li>● Looseness of the base bolts.</li> </ul>	<ul style="list-style-type: none"> <li>○ Replace the bearing.</li> <li>○ Contact your supplier.</li> <li>○ Re-tighten bolts.</li> </ul>
	Connecting pipe	<ul style="list-style-type: none"> <li>● Scratch, flaw, crack.</li> <li>● Corrosion.</li> <li>● Deformation.</li> <li>● Liquid leakage from seal parts.</li> </ul>	<ul style="list-style-type: none"> <li>○ Replace the parts.</li> <li>○ Replace the parts.</li> <li>○ Remove load on piping if any.</li> <li>○ Replace the O-ring if liquid leakage.</li> </ul>
	Casing	<ul style="list-style-type: none"> <li>● Scrtch, flaw, crack.</li> <li>● Scale buildup inside of the WPK.</li> <li>● Swlling and corrosion of the O-ring.</li> </ul>	<ul style="list-style-type: none"> <li>○ Replace the parts.</li> <li>○ Remove scales.</li> <li>○ Replace the parts. (When disassembly, replace to the new O-ring.)</li> </ul>
	Impeller	<ul style="list-style-type: none"> <li>● Sliding mark on the impeller .</li> <li>● Corrosion.</li> <li>● Looseness of impeller nut.</li> </ul>	<ul style="list-style-type: none"> <li>○ Replace the parts.</li> <li>○ Replace the parts.</li> <li>○ Remove the nut / impeller and check for corrosion on shaft and re-tighten it. If shaft is corroded, contact your supplier.</li> </ul>
	Seal case	<ul style="list-style-type: none"> <li>● Abrasion &amp; corrosion of the oil seal.</li> </ul>	<ul style="list-style-type: none"> <li>○ Replace the parts if it is corroded or worn away greatly.</li> </ul>

## ■ DISMANTLING AND ASSEMBLING

- Referred to the Page 5 and Page 15 about the number after the parts' name.
- Dry seal holder (16), O-ring (18) and Bolt (19) are not attached with the pump (5.5kW and more).
- The pump for high temperature does not have the Cut seal (23).
- YD-400\*VK3 does not have Cut seal (23).
- The parts of the pump (Joint type) are the different and refer to the corresponding drawing.

### □ Disassembly procedure

1. Wash the inside of the pump that is removed from the installation stand and disassemble it. When the pump is upended, it is easy to disassemble the pump.
  2. Remove the bolts and nuts (8) and remove the casing (6) and O-ring (7).
  3. When removing the impeller (12), lock to rotate the blades of the impeller with a screwdriver and turn the impeller nut (9) counterclockwise with a wrench. Next, withdraw the impeller (12) from the pump shaft (1)-A. It is available to remove O-rings (7) (10) (18), the cut seal (23) and the key (11).
  4. Pulling out of the back plate (13) is available after removing the impeller (12). Removing bolts (4) after removing O-ring (7) and pull out the connecting pipe (5).
  5. Remove the dry seal holder (19). Pull out the dry seal holder (16) from the pump shaft (1)- A after inserting a box screwdriver (for M6) into the opening on the side of the base (3) and remove bolts (19).
  6. Remove the seal case (17) from the base (3). It is available to remove the O-ring (15) and dry seal (14). Remove bolts (2) and it is available to remove the base (3) from the motor (1).
- All procedure of the disassembly is above from 1 to 6.

### □ Assembly

1. Keep the motor side down and wipe off dirt and foreign materials of the pump shaft with clothes.
2. Insert the dry seal holder (16) in the pump shaft (1)-A. Align the bolt (19) to the hole at the end of the pump shaft and fix the set bolt by a box screwdriver (for M6). (Refer to the exploded view 5).
3. Attach the base (3) to the motor, and tighten the bolts (2) for fix.  
The tightening torque of bolts (2) is 9.8N·m (100kgf·cm).
4. Attach the seal case (17), O-ring (15) and dry seal (14) to the base (3) in this order. Set the dry seal (14) at the setting position on the dry seal holder (16). (Refer to the exploded view 4,5)  
When it is the pump with the motor 5.5kW and more, set the dry seal at the ditch of the dry seal on the shaft sleeve with the impeller (12). (Notice 1: Refer to the position of the dry seal)
5. Attach the connecting pipe (5) to the base (3), and tighten the bolts (4) for fix. The tightening torque of the bolts (4) is 9.8M·m (100kgf·cm). Put the O-ring (7) on the back plate (13), and attach them to the connecting pipe (5) (Refer to the exploded view 3).
6. Insert the key (11) into the key groove located at the end of the pump shaft (1)-A.
7. Set the cut seal (23) and O-ring (18) to the impeller (12) in this order. Set the cut seal (23) like the exploded view 6. Set the O-ring (18) like the exploded view 3.
8. Fix the impeller (12). Install O-ring (10) to the impeller nut (9) and tighten the impeller nut (9) at the end of the pump shaft. Lock to rotate the blades of the impeller by a screwdriver and turn the impeller nut (9) clockwise with a wrench.

The tightening torque for the impeller nut (9) is 9.8N·m (100kgf·cm).

9. Install the O-ring (7) into the casing (6). Attach the casing with O-ring. Set the discharge flange of casing at the opposite side of the motor terminal box. Check that the O-ring is placed properly by looking through the gap between the casing (6) and connecting pipe (5).
10. Fix the casing (6) with bolts (8). The tightening torque is 9.8N·m (100kgf·cm). Tighten the bolts (8) evenly not to be uneven clamping.

\* Put the hand into the suction inlet after installing the casing (6) and check that the impeller (12) rotates.

**Note 1:**

Dry seal holder (16) is not included with a pump with 5.5kw motor or larger.

In this case, the O-ring (18) and the bolts (19) are not used. However, it is necessary to install the dry seal.

**Note 2:**

When assembly, replace O-rings, gaskets and seals to new ones.

- **Reference tightening torque**

Bolts for the motor (2), connecting pipe (4), casing (8) and impeller nut (9): 9.8N·m (100kgf·cm)

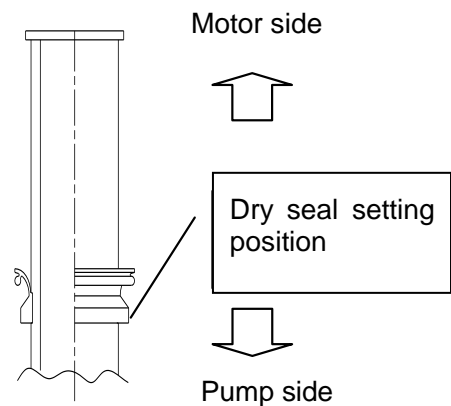

All assembly procedure is above from 1 to 10.

# EXPLODED VIEW

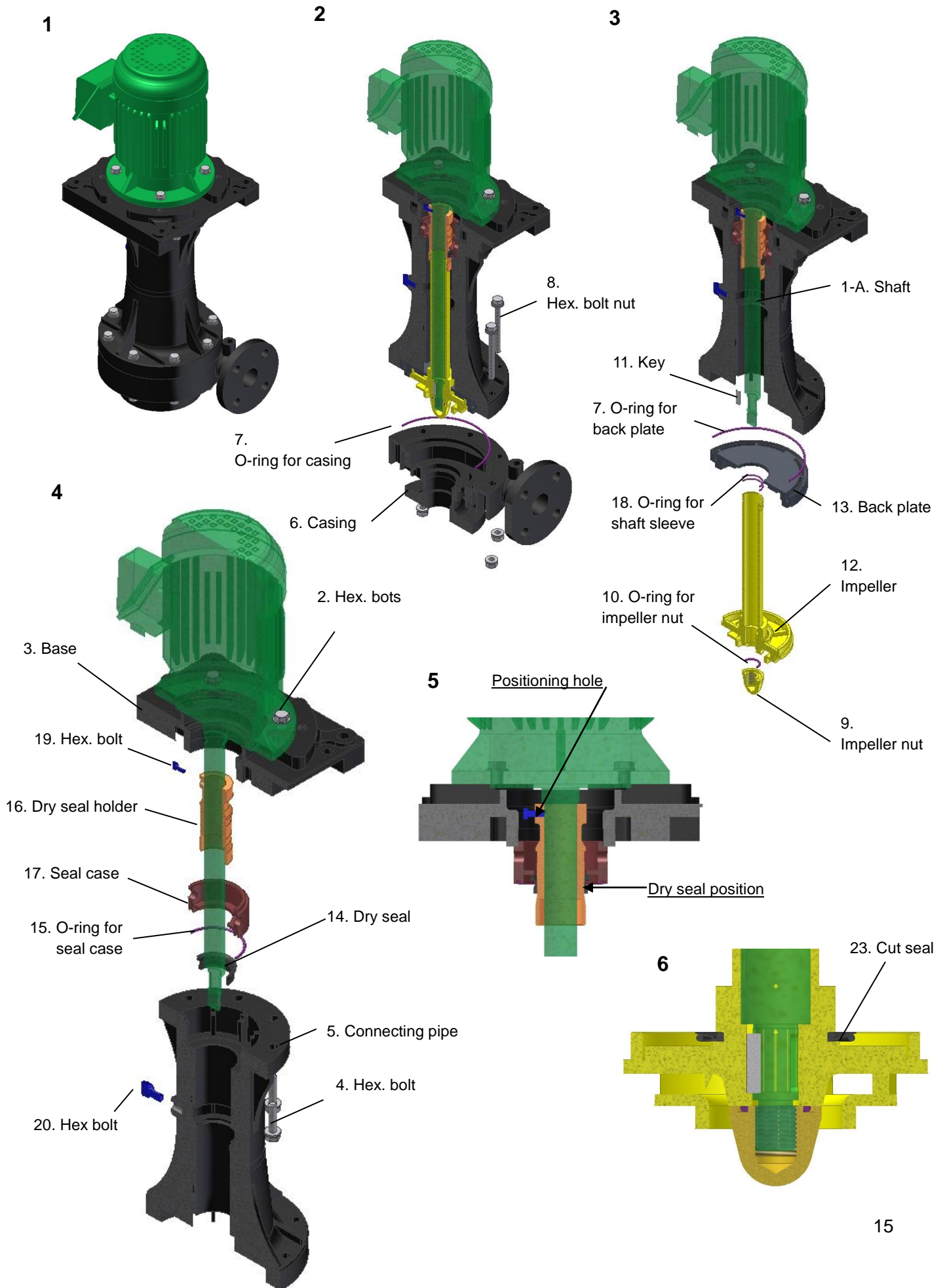



## ■ LIMITED WARRANTY / REPAIR

### 1. Warranty period and coverage

- (1) The warranty period is one year from the date of shipping out of our factory.
- (2) During warranty, if the pump breaks down or becomes damaged under that normal operation for manufacturing defects, they are repaired free of charge.
- (3) We provide no warranty support if the defect or damage is caused by any of the following:
  - Breakdown or damage occurred after the warranty period.
  - Breakdown or damage for improper use or safekeeping.
  - Breakdown or damage caused by the use of unauthorized parts of service.
- (4) We cannot be responsible for the break down or damage of the customer-specified pump.
- (5) Irregularities or breakdowns due to chemical or hydrodynamic corrosion by liquid are not covered under the warranty. The material chosen at the time of the contract is only a recommendation. We do not guarantee the chemical resistance of the material.
- (6) If the determination of the cause for the breakdown or damage is questionable, it attribute to the negotiation between the customer and us.
- (7) Travel expenses incurred for non-warranted repair to a remote location are charged.
- (8) Expenses or other damage incurred as a result of breakdowns during operation are not covered under the warranty.

### GOOD PROTECTION AND MUST BE CAPITALIZED

WE ARE NOT RESPONSIBLE OR LIABLE FOR ANY LOSS, INCONVENIENCE OR DAMAGE, WHETHER SPECIAL, DIRECT, INCIDENTAL, CONSEQUENTIAL, OR OTHERWISE, AND WHETHER KNOWN OR SHOULD HAVE BEEN KNOWN TO US, INCLUDING LOST PROFITS, GOODWILL, DAMAGE TO OR REPLACEMENT OF OTHER EQUIPMENT AND PROPERTY AND PERSONAL INJURY RESULTING FROM ANY BREACH OF WARRANTY, THE INABILITY TO USE THE PRODUCT OR UNDER ANY LEGAL THEORY IN CONTRACT OR TORT. THESE WARRANTIES AND REMEDIES ARE YOUR SOLE AND EXCLUSIVE WARRANTIES AND REMEDIES IN CONNECTION WITH THE SALE AND USE OF THE PRODUCT. NO OTHER WARRANTIES, ORAL OR WRITTEN, EXPRESS OR IMPLIED, ARE GIVEN. OUR LIABILITY IS LIMITED TO THE ACTUAL PURCHASE PRICE YOU PAID TO THE RETAIL SELLER OF THE DEFECTIVE PRODUCT.

### THIS IS MANDATORY:

Some states do not allow the exclusion or limitation of implied warranties or liability for incidental or consequential damages, or do not allow a limitation on how long an implied warranty lasts, so the above limitations or exclusions may not apply to you. You are advised to contact applicable state laws for a full determination of your rights. This warranty gives you specific legal rights, and you may have other rights which vary from state to state.

## GOOD PROTECTION:

No dealer, agent or employee is authorized to make any modification, extension, change or amendment to this warranty.

## REPAIR

### **Notice:**

For repair, consult with your supplier. When returning a pump, clean the wet parts kit thoroughly.

If any irregularity is detected during operation, stop and check the pump. (Refer to the section on “*Troubleshooting*”).

- (1) To request a repair, ask your supplier or us.
- (2) Before requesting a repair, read the instruction manual again and recheck it.
- (3) When requesting a repair, provide the following information:
  - Model name and serial number
  - Used period and condition
  - Damaged parts and condition
  - Type of liquid (name, specific gravity, liquid temperature, and slurry or not)

Make sure to clean the inside not to leak the liquid during transportation.

When ordering parts, provide parts' number and material as well as parts name form the outline dimension or parts list.



## **WORLD CHEMICAL CO., LTD. / Japan**

### **Head Office / Overseas department**

3F., ANTEX24, 1-1-14, Taito. Taito-ku, Tokyo, 110-0016 Japan

TEL: 03-5818-5130 FAX: 03-5818-5131 (Head office)

TEL: 03-5818-5131 FAX: 03-5818-5131 (Overseas department)

### **Osaka Office**

7F., KUJO Bldg., 1-27-6, Kujo, Nishi-ku, Osaka-shi, Osaka, 550-0027 Japan

TEL: 06-6584-3185 FAX: 06-6584-3160

### **Nagoya Office**

1F., EIKEI Bldg., 1-307, Yashirogaoka, Meito-ku, Nagoya-shi, Aichi, 465-0051 Japan

TEL 052-701-1227 FAX 052-701-1250

### **Tsukuba Factory**

6127-5, Onogo-machi, Joso-shi, Ibaraki, 300-2521 Japan

TEL 0297-24-1071 FAX 0297-24-1075

## **WORCHEMI TAIWAN CO., LTD. / Taichung, Taiwan**

No.915, Zhongshan Rd., Shengang Dist., Taichung City 42955, TAIWAN

TEL 886-4-2562-8358 FAX 886-4-2562-8351

## **WORLD CHEMICAL USA, INC. / California, U.S.A.**

30 Hughes, Suite 203, Irvine, CA 92618, U.S.A.

TEL 1-949-462-0900 FAX 1-949-462-0999

## **SUZHOU WORLD TECHNOLOGY CO., LTD. / Jiangsu, China**

402, Fu Yuan Road, Xiang Cheng Economic District, Suzhou, Jiangsu Province, China

TEL 86-0512-6579-8212 FAX 86-0512-6579-8215