

**Float pump to collect floating objects / oil**

# **GYRO SKIMMER**

**YD-1000GYP**  
**(with submersible pump)**

INSTRUCTION MANUAL

Version: 230508



Thank you very much for purchasing our GYRO SKIMMER.

This is a system which collects floating oil efficiency and is configured with floats and a submersible pump.

This manual describes features of the parts and procedure. Please read and understand this manual thoroughly.

## TABLE OF CONTENTS

<b>I. MODEL DESCRIPTION .....</b>	<b>2</b>
<b>II. FEATURES .....</b>	<b>3</b>
<b>III. FLOAT .....</b>	<b>5</b>
<b>IV. SUBMERSIBLE PUMP .....</b>	<b>7</b>
<b>V. WARRANTY / REPAIR .....</b>	<b>16</b>

**Notice:**

This manual describes the explanation of products with standard specification. In case of products with non-standard specification, read the manual with replacing items and words to those of non-standard one.

# GYRO SKIMMER

## YD-1000GYP Instruction manual

### I. MODEL DESCRIPTION

**YD – 1000 GYP – 00 V06 620 (N) (T)**  
(1) (2) (3) (4) (5) (6) (7)

(1) Float diameter

600 :  $\phi$  560, 800 :  $\phi$  780, 1000 :  $\phi$  1000, 1200 :  $\phi$  1200

(2) Model

GYP series

(3) Power of the submersible pump

A6 : 0.25kW (1PH), Y6 : 0.25kW, A0 : 0.4kW (1PH), 00 : 0.4kW,  
01 : 0.75kW, 02 : 1.5kW

(4) Cable material & length of the submersible pump

V : VCT P : 2PNCT / 06 : 6m (The length is described as meter.)

(5) Frequency & Voltage of the submersible pump

5 : 50Hz 6 : 60Hz

10 : 100V, 20 : 200V, 22 : 220V, 38 : 380V, 40 : 400V

● The option and specialty are indicated as follows.

(6) Anti-dust net

N : with Net

No indication : without Net

(7) Specialty

T : Special conditions

## II. FEATURES

1. This is configured with three large floats (main float), three small floats (gate float), a gate ring and a submersible pump to float the main body and collect floating oil.
2. The main floats have enough buoyancy to support the weight of the submersible pump and flexible hose.
3. The gate floats make the oily water inlet (gate ring) and liquid level (inflow drop) keep constant even if the surface is fluctuated.
4. The main floats and gate floats move up and down independently. The flow drop of the gate ring is not affected by the movement of main floats and oil can be collected stably.
5. It is easy to adjust the flow drop of the gate ring by turning itself and collect thin oil layer of the surface.
6. The skimmer is combined with a pump. By simply connecting a flexible hose and supplying power, it collects the oil layer towards the gate ring and suction hopper during drawing continuously. The suction hopper is integral with the casing of the submersible pump.
7. The submersible pump smoothly transfers entered oily water and solids from the gate ring and have the quality of last long.
8. Besides the submersible pump, there is no electrically operated part. It is easy to handle it and perform maintenance like washing.
9. The parts except the pump are originally designed. The well-balanced one makes the ability exert fully.



### III. FLOAT

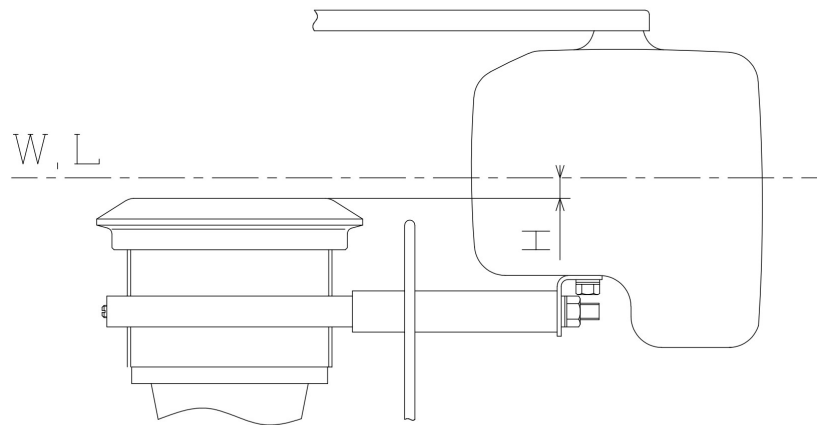

1. GYRO SKIMMER does not have any operation control switch or protection device at time of the electrical leakage or short circuit, so install an electrical leakage circuit breaker with AC power. Besides, set up the ON/OFF switch.
2. Connect the cable of the submersible pump to the AC power.
3. Float the body in the oily water of water with solids after the flexible hose is connected to the hose joint at the discharge outlet of the submersible pump and fix the hose with a hose band securely.
4. Three holes on the top of the main float is used for lifting and tying up the product. Fix the skimmer at the place where floating oil stays.
5. Do not apply an excess force to the flexible hose connected with the submersible pump. If the tension is applied to the flexible hose during the skimmer is tied up, oil is not collected uniformly by the inclined gate ring or the up and down action may be badly affected, because the slide parts of the suction hopper and gate ring is held.
6. Check that the gate ring and suction hopper are submerged.
7. The inflow drop of the gate ring (H in the above picture) is adjusted in our factory (freshwater) before shipment. However, readjustment is required in case of using for liquids other than freshwater, thick oil layer, high viscosity floating oil or a low specific gravity liquid. H is affected by them.

8. When H is adjusted, turn the gate ring while the gate float is held by hand.
9. Turning the gate ring clockwise as viewed from above makes H bigger and the oil-water flow rate increases. On the other hand, turning it counterclockwise makes H smaller and the flow rate decreases.
10. Adjust H according to a balance of the property (like viscosity and specific gravity) / thickness of oil and capacity of the pump.
11. The best flow drop H is that the collected oil steams down on the inside wall of the suction hopper through the gate ring as a thin layer.
12. For the smooth operation, perform maintenance like take the skimmer out from the tank, wash it and retighten the bolts at the connections depending on the dirt.
13. If the floats get dirty, foreign objects like sludge is easily adhered. As they become larger, the floats become harder to follow the waves. When foreign objects accumulate between the main floats and gate floats, it disturbs the independent movements of each other.
14. Keep watch dirt of the gate ring and suction hopper. The suction hopper and gate ring slide each other along the movement of floats. If they get dirty or solid foreign materials, the smooth movement is disturbed.

**Notice:**

Maintain the submersible pump after removing the pump from the main unit. The submersible pump is installed up and down from the original position. Therefore, if checking oil by the state of pulling up from a tank, oil drains from the oil filling port.

# IV. SUBMERSIBLE PUMP

## 1. BE SURE TO READ FOR YOUR SAFETY

Be sure to thoroughly read this SAFETY PRECAUTIONS before using.

The precaution describes to use the skimmer correctly and prevent danger of damage to you or to others. The precautions are classified into two categories: WARNING and CAUTION to clear the level of the harm and damage and urgency. However, CAUTION may at times lead to a more serious problem, too. In either case, they are indications for safety and be observed carefully.

- **WARNING:** It may lead to death or injury to humans, if ignoring the sign.
- **CAUTION:** It may cause injury to humans and other physical damage, if ignoring the sign.
- **NOTICE:** Others.
- **Explanation of symbols**



: It shows Danger, Warning or Caution. The inside symbol shows the abstract context. (The left means Caution for electric shock.)



: It shows prohibition. The inside symbol shows the abstract context. (The left means Disassembly prohibition.)



: It shows imposition or instruction. The inside symbol shows the abstract context. (The left means Wire the earth cable.)

### Precaution to the specification

<b>CAUTION</b>	
	<ul style="list-style-type: none"> <li>● Do not use the product for other than the set specification. If not, it leads to <b>electrical leakage, electrical shock, fire or liquid leakage.</b></li> </ul>

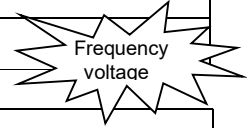













### Precaution for transportation/installation









<b>WARNING</b>	
	<ul style="list-style-type: none"> <li>● Install the product properly under the manual. If it is failure, it causes electrical leakage, electrical shock, fire, water leakage, or injury.</li> </ul>
	<ul style="list-style-type: none"> <li>● Set electrical wiring under the electric regulations. Wiring failure causes electric leakages or fire.</li> </ul>
	<ul style="list-style-type: none"> <li>● Use the 15A outlet by itself. If using with other instrument, it may burn by abnormally heated.</li> </ul> <p style="text-align: center;">15A and more</p>
	<ul style="list-style-type: none"> <li>● Wire the earth cable securely and not in conjunction and install Earth leakage circuit breaker. If electric leakage occurs when at the time of pump failure, it may cause electric shock.</li> </ul>
<b>CAUTION</b>	
	<ul style="list-style-type: none"> <li>● Wire the earth cable securely. Do not connect to gas pipe, water pipe, lightning rod, or telephone wire. If it is failure, electric shock may occur.</li> </ul>
	<ul style="list-style-type: none"> <li>● Do not scratch, fold, twist, make alterations, or bundle the cable. It causes the cable damage and electric shock, short, electric shock and fire.</li> </ul>
	<ul style="list-style-type: none"> <li>● Prevent pins or dust from the power plug. It causes fire.</li> </ul>
	<ul style="list-style-type: none"> <li>● Do not use the damaged cable and plug and connect the tip of the cable to the terminal block securely. If failure, it causes electric shock, short or fire.</li> </ul>
	<ul style="list-style-type: none"> <li>● Carry the pump by hands with enough people. When lifting it, do not bend over. It causes back trouble.</li> </ul>
	<ul style="list-style-type: none"> <li>● Do not install the pump at a dusty place or where toxic, corrosive or explosive gas, because it is neither dust-proof nor explosion-proof. It may cause fire.</li> </ul>
	<ul style="list-style-type: none"> <li>● When using a hose, set it without moving. If happen, it causes injury.</li> </ul>





## PRECAUTIONS DURING TEST OPERATION AND OPERATION

 <b>WARNING</b>			
	<ul style="list-style-type: none"> <li>Do not use the pump in the tank where somebody stays. If electric leakage occurs, electric shock may happen.</li> </ul>		<ul style="list-style-type: none"> <li>When changing the connection, make sure to turn off the power and stop the impeller. If not, it may cause electric shock, short or injury.</li> </ul>
	<ul style="list-style-type: none"> <li>Do not start the pump when hanging. It may cause injury for the back action.</li> </ul>		<ul style="list-style-type: none"> <li>Make sure to turn off the power to prevent to start the pump accidentally when maintenance. If happen, it may cause serious accident.</li> </ul>
 <b>CAUTION</b>			
	<ul style="list-style-type: none"> <li>Do not use the pump with no rated voltage. When using a generator, do not use other equipment together. It causes a bungle, the pump damage, electric leakage or shock.</li> </ul>	 <small>Rated Voltage</small>	<ul style="list-style-type: none"> <li>The motor may be hot. Do not touch the product by bare hands during or after the operation. It may cause burn.</li> </ul>
	<ul style="list-style-type: none"> <li>Do not use the pump with high temperature liquid. It causes the pump damage, electric leakage or shock.</li> </ul>		<ul style="list-style-type: none"> <li>Do not dry run. It causes the pump damage, electric leakages or electric shock.</li> </ul>
	<ul style="list-style-type: none"> <li>Do not put foreign objects into the suction inlet. It causes the pump damage or abnormal operation.</li> </ul>		<ul style="list-style-type: none"> <li>If it is not used for a long time, turn off the power or pull the cord out of the wall. If the insulation becomes depleted, it causes electric leakage, electric shock or fire.</li> </ul>

## PRECAUTIONS WHEN MAINTENANCE

 <b>WARNING</b>			
	<ul style="list-style-type: none"> <li>When maintenance, make sure to turn off the power or pull the cord out of the wall. Do not do by wet hands. It may cause injury by electric shock.</li> </ul>		
	<ul style="list-style-type: none"> <li>At an abnormal, stop the operation and contact your supplier. If continued, it causes electric shock, fire or liquid leaks.</li> </ul>		
 <b>CAUTION</b>			
	<ul style="list-style-type: none"> <li>At the restart after reassembly, do the trial operation. If the assembly failure, it causes abnormal action, electric shock or liquid leakage.</li> </ul>		<small>Tria</small>

## PRECAUTION WHEN ELECTRIC POWER FAILURE

	<ul style="list-style-type: none"> <li>When electric power failure, stop the operation. The pump which starts accidentally after recovery is danger for the people surrounding the pump.</li> </ul>	
---	---	---

## OTHERS

	<ul style="list-style-type: none"> <li>Do not use the product for drinking water. It may have an affect on the human body.</li> </ul>	
---	---	---

## 2. PARTS NAMES

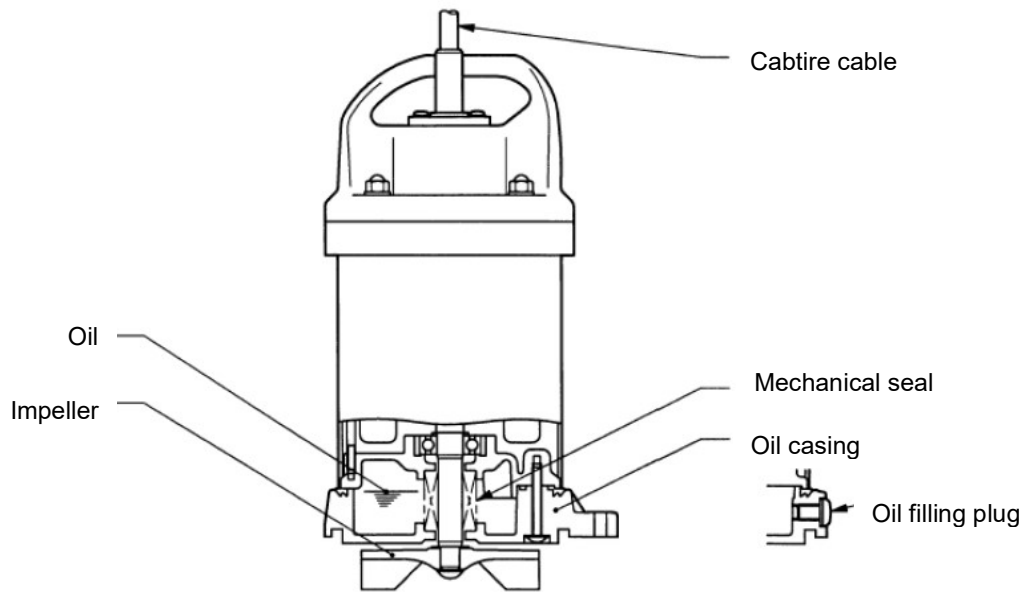

## 3. BE SURE TO READ FOR YOUR SAFETY

When receiving the product, check the followings.

### ➤ Product check

Unpack and check that there are damage parts or loosen bolts and nuts during transportation.

### ➤ Specification Check

Check that the product is what you ordered by checking the nameplate, especially the voltage and frequency.

Notice: If there is any defect, contact your supplier.

### ➤ Specification



**CAUTION:** Do not use the product under any conditions other than the structured specification. If use, it causes electric shock, electric leakage, fire or liquid leakage.

### ■ Major Standard Specifications

Liquids	Consistency and Temperature	Water, waste water, sewage • 0 - 40°C
Pump	Impeller	High spin
	Sealing	Double Mechanical Seal
	Bearing	Shielded Ball Bearing
Motor	Specification	Dry Submersible Induction Motor, 2-Pole
	Insulation	Class E
	Protection Equipment (built-in)	Miniature Protector (1PH), Thermal Protector (3PH)
	Oil	Turbine oil, V32 (Addictive-free)

## 4. INSTALLATION



**CAUTION:** Observe the followings. If not, it causes the pump damage, electric leakage or electric shock.

- It is possible to temporary use the product by sea water, but do not use it constantly.

Notice: Wash it thoroughly with tap water after using by sea water to prevent salt and corrosion.

- Use it with the rated voltage of plus or minus 5 % or less.
- The water temperature is 0 – 40 degrees.

**Note:** If using the product for a special solution, contact your supplier.

### ■ Maximum Allowable Pressure



**CAUTION:** Do not use the product where it is affected by the following number and more.

Applicable Pump	Maximum Allowable Pressure
Output: 0.75kW or less	0.2MPa(2kgf/cm <sup>2</sup> ) – discharge pressure during operation
Output: 1.5kW	0.3MPa(3kgf/cm <sup>2</sup> ) – discharge pressure during operation

### ➤ Precaution before installation

#### ■ Single phase

Measure the resistance between the tip of the cabtire cable plug and grounding electrode (clip) and check the resistance of the motor insulation.

If the tip does not have a plug, measure the resistance between the core wire of the cabtire and earth cable (green) with an insulation resistant tester and check the insulation resistance of the motor

#### ■ Three phase

Measure the resistance between the core wire of the cabtire cable and earth wire (green) by an insulation resistant tester and check the insulation resistance of the motor.

Insulation resistance reference value  
=20M Ω minimum

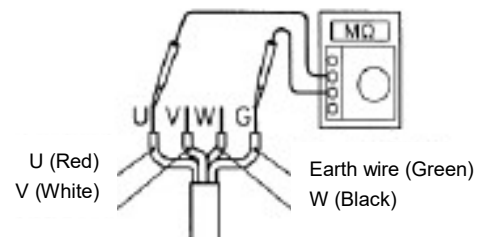
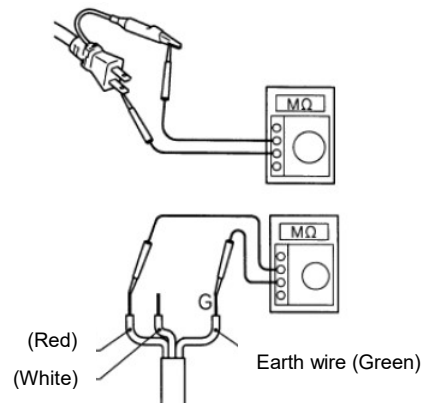

**Note:** The insulation resistance reference value of 20M Ω minimum is based on a new or repaired pump. For reference values of a pump that has already been put into operation, refer to “7. Maintenance

## 5. ELECTRICAL WIRING

### ➤ Electrical Wiring Work



#### WARNING

- Electrical work is performed by an authorized electrician, in compliance with local electrical equipment standards and internal wiring codes. An unauthorized person is not allowed the electrical work not only against the law, but also it is dangerous.
- Improper wiring leads to current leakage, electrical shock, or fire.
- Make sure to install a dedicated earth leakage circuit breaker and a thermal overload relay suitable for the pump. If not, it may cause electric shock when pump damage and liquid leakage.

Provide enough capacity of the power supply and wiring.

### ➤ Earth



#### WARNING

Make sure to connect the earth wire. If not, electric shock may occur when pump damage or liquid leakage.



#### CAUTION

Do not connect the earth wire to gas pipe, water pipe, lightning conductor or telephone earth wire. If the earth wire is failure, it may cause electric shock.

### ➤ Connecting Power



#### WARNING

Make sure to turn off the power before connecting the plug or the connecting terminal block. If not, it may cause injury by electric shock, short, unexpected pump start.



#### CAUTION

If the cable or plug is damaged or failure, do not use it. It may cause electric shock, short or fire.

Connect as follows.

#### ■ Single phase

Connect the specified electrical leakage circuit breaker for the pump (Plug in type). (Separated commercial item)

#### ■ Three phase

Make sure to connect the connecting terminal at the tip of the cable to the terminal block of the control board without loosening.

### ➤ Motor protector

The motor protector (Miniature protector or thermal protector) is built in.

If overcurrent or abnormal heating occur for the following causes, stop the pump without any reference to the operation liquid level and it protects the motor.

- Drastic change of the voltage
- Overload operation
- Open-phase operation or restraint operation
- 

**Note:** The motor protector is automatically deactivated, so remove the cable from the terminal block and plug and make sure to eliminate the cause of problem. Do not operate the pump when the liquid level is very low or the impeller has foreign objects. It may cause noise, abnormal vibration or pump failure.

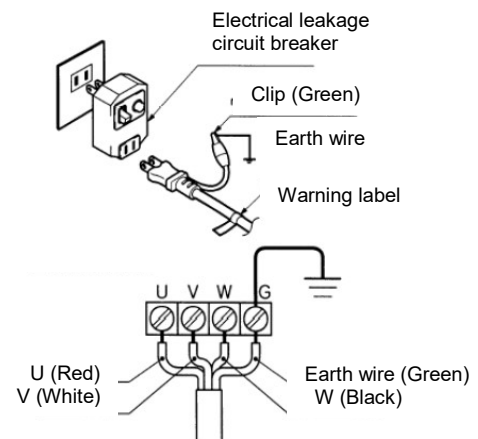

## 6. OPERATION

### ➤ Before operation

- (1) Once again, check the voltage and frequency in the nameplate.

**⚠ CAUTION** If they are wrong, not only the high performance is not delivered, but also the pump failure may occur.

- (2) Check the wiring, the voltage, the capacity of the earth leakage circuit breaker, and the insulation resistance of the motor. \* Insulation resistance reference value is 20MΩ and more.

**Note:** The insulation resistance reference value is based on a new or repaired pump. Regarding the value after installation, refer to “Daily check / Periodical check”.

- (3) Coordinate the setting value of the thermal relay (3E relay) with the current rating of the pump.

**Note:** The current rating is in the nameplate.

### ➤ Trial operation

**⚠ WARNING** Do not start the pump with hanging. It may cause serious injury by back action for the rotating.

- (1) Check the rotating direction in manner of 1. If impossible, check it in manner of 2.

1. Operate the pump in a 1 or 2 seconds and visually check the rotating direction of the impeller from the above the gate. When operation, fix the pump by hanging rope to prevent the moving and falling.
2. Check the direction of the back action of the pump at the start after set the product on the water. The impeller rotates anticlockwise as the view of the above. The main body moves clockwise instantly by the back action of the start. It is possible to check the rotating direction by the back action.

**⚠ CAUTION** Do not put hands or tools into the pump through the gate during operation for checking. It causes serious accidents by the rotating impeller. If it rotates backward for long time, it may cause the pump failure, liquid leakage or electric shock.

- (2) The measure when it rotates backward.

**⚠ WARNING** When the connection change, make sure to turn off the power and stop the impeller rotating. If not, electric shock and short may occur.

Measure: Switch two phases, U, V or W.

- (3) Connect the pump to pipes and submerge it.

- (4) Operate the pump for 3 – 10 minutes and check the below.

- Check the operation current at U, V, W phase with a clamp meter.

Measure: If the current is over, it may be overload. Refer to 4. INSTALLATION.

- Check them at the terminal block by using a current gauge.

\* Acceptable amount of the voltage:  $\pm 5\%$  or less than the rated voltage.

Measure: If the voltage is over or less than the above acceptable amount of the voltage, it may cause the capacity of the power or the extension cable. Refer to 5. ELECTRIC WIRING.

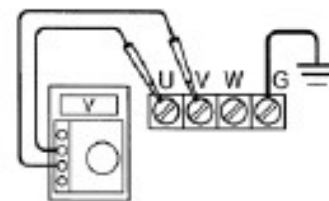
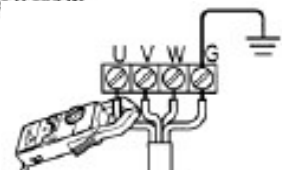
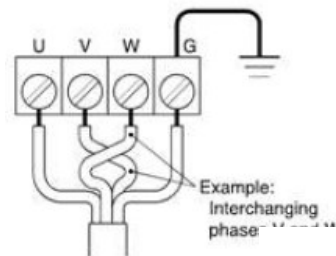

**⚠ CAUTION** If the very hard vibration, noise or smell occurs, stop the operation and contact your supplier. If the operation is continued, it may cause electric shock, fire or liquid leakage.

- (5) When no trouble at the trial operation, operate it continuously.

## 7. MAINTENANCE / CHECK

Regular maintenance is necessary to keep the pump's ability. If any failure, refer to 9. TROUBLESHOOTING and take measures shortly. It is recommended to prepare a spare pump for an emergency, if possible.

### ➤ Before check



#### WARNING

Make sure to turn off the power and remove the cable from the terminal block. If not, serious accident may occur by electric shock or unexpected start the pump.

(1) Washing pump: Remove any fouling on the pump and wash it with tap water. Completely remove any fouling on the impeller especially.

(2) Pump exterior check: Check no damaged parts or loosened bolts or nuts.

**Note:** If any parts are damaged or bolts and nuts are loosened, disassembly may be necessary. At that time, contact your supplier.

### ➤ Daily check / Periodical check

Interval	Check item
Daily	Operating current check ■ Within the rated current Voltage check ■ Acceptable value of voltage = within ±5% of the rated voltage
Monthly	Insulation resistance check ■ Reference value=1MΩ minimum <b>Note:</b> If the insulation resistance is drastically lower than previous check, check the motor.
Yearly	Oil check (Output: 0.75 kW or less) ■ 3,000 hours or 12 months, whichever comes first
	Oil check (Output: 1.5 kW and more) ■ 6,000 hours or 12 months, whichever comes first
Once 2 years	Oil check (Output: 0.75 kW or less) ■ 4,500 hours or 24 months, whichever comes first
	Oil check (Output: 1.5 kW and more) ■ 9,000 hours or 24 months, whichever comes first Change the mechanical seal. <b>Note:</b> The special knowledge is necessary to maintain or replace the mechanical seal. Contact your supplier, if necessary.
Once 2 to 5 years	Overhaul ■ Even if there is no failure, do the overhaul. When the pump is operated continuously, it is recommended to do overhauled earlier. <b>Note:</b> When overhaul, contact your supplier.

**Note:** Refer to section “Oil check / Replace procedures”.

**Note:** If the wastewater contains fine refuse like grease, paint or fine ash, it is necessary to check earlier, because the cable swollen or immersion from the mechanical seal cause the failure.

### ➤ Storage

If the pump is not operated for a long time, pull up and wash the pump. Store it indoors.

**Note:** When reinstallation, try a trial operation before the normal operation.

If the pump remains immersed in water, operate it on a regular basis (i.e. once a week).

### ➤ Oil check / Replace procedures

#### Oil check

Remove the oil plug and take out a small amount of oil. It is easy to drain oil by declining the pump that the oil filler plug faces downward. If the oil appears milky or intermixed with water, the seal such as mechanical seal may be failure. At that case, it is necessary to disassemble or repair the pump.

#### Replace oil

Remove the oil plug and drain oil completely.

Pour a specified volume of oil from the oil filling port.

**Note:** Do not dispose oil to the sewer or rivers and take appropriate measure. When oil check or oil replace, replace to new packing and O-ring each time.

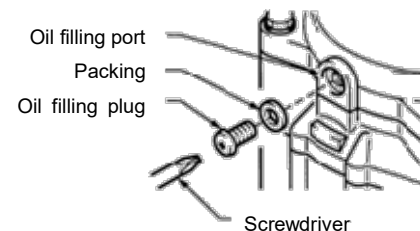

Designated oil : Turbine oil VG32 (Additive-free) ml

Model	Defined amount
Output: 0.25-0.75kW	240
Output: 1.5kW	500

## 8. DISASSEMBLING / ASSEMBLING PROCEDURE



### WARNING

When the product is disassembled or assembled, make sure to turn off the power (Ground-fault circuit interrupter, etc.) and pull out the cable from the plug or terminal block. Do not operate it with wet hands. It causes electric shock. Besides, never do the test (impeller rotation, etc.) with power supply during disassembly or assembly. It may lead to serious accident like injury.

The disassembling and assembling procedure from the start to impeller replacement are shown here. Regarding the disassembly and assembly of the sealing part (mechanical seal) and motor, a vacuum fixture or electrical test facility are needed.

### ➤ Exploded view

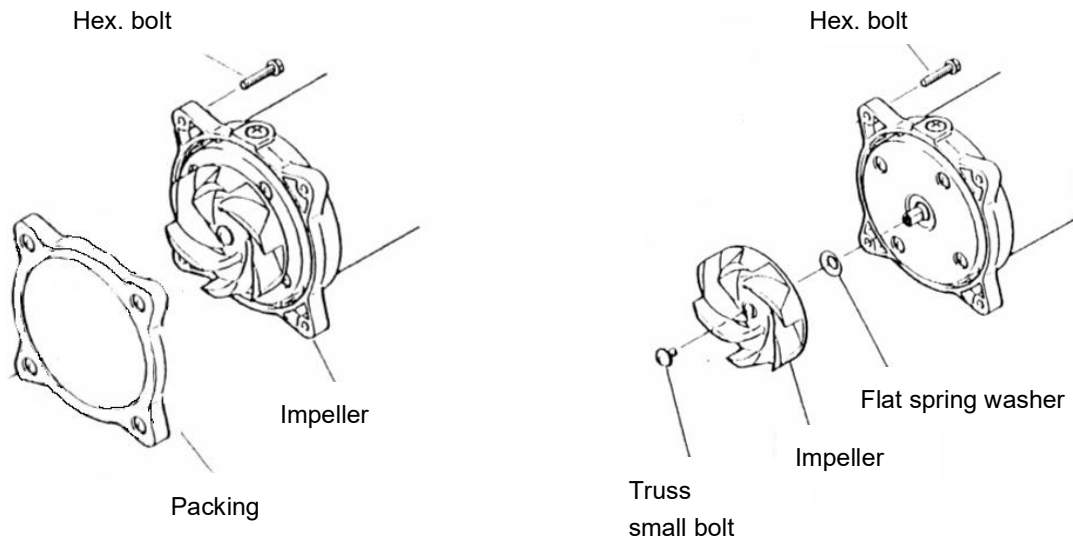

### ➤ Assembling procedure

Assemble the product according to the following notice by the procedure at the opposite of the disassembly.

- (1) Firstly, clear all parts thoroughly and assemble them.
- (2) Make sure to install O-rings.
- (3) Be careful to insert the following part.  
Flat spring washer

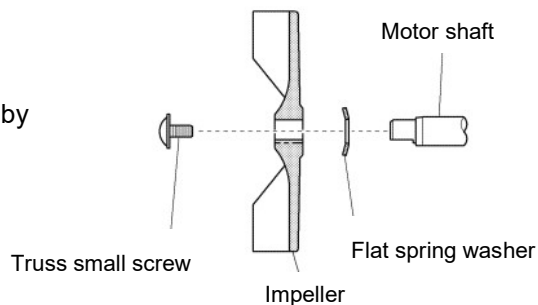

[Direction to install the flat spring washer]

## 9. TROUBLESHOOTING



### WARNING

When maintenance, make sure to turn off the power. If not, it may cause serious accident.

Read this Operation Manual carefully before requesting repair. Check again and contact your supplier if any abnormality.

State	Cause	Measure
The pump does not work or stops immediately.	<ul style="list-style-type: none"> <li>① Power is not supplied (i.e. power outage).</li> <li>② Malfunction in automatic control (control panel)</li> <li>③ The protector works, because foreign objects are clogged.</li> </ul>	<ul style="list-style-type: none"> <li>① Contact the electric power company or an electrical repair shop.</li> <li>② Investigate the cause and repair.</li> <li>③ Check the pump and remove the objects.</li> </ul>
The pump stops after a certain amount of time.	<ul style="list-style-type: none"> <li>① The protector works, because the pump is operated while exposing for a long time.</li> </ul>	<ul style="list-style-type: none"> <li>① Operate the pump for 15 minutes once after the re-start.</li> </ul>
The protector of the power works.	<ul style="list-style-type: none"> <li>① The pump specification is not suitable for the equipment.</li> <li>② The motor trouble (Burn out or submergence)</li> <li>③ The pump for 50Hz is operated with 60Hz.</li> </ul>	<ul style="list-style-type: none"> <li>① Replace to the appropriate equipment or set the correct value.</li> <li>② Repair or replace.</li> <li>③ Check the nameplate and replace the pump or impeller.</li> </ul>
The pump is working, but no pumping.	<ul style="list-style-type: none"> <li>① The pump is locked by air.</li> <li>② The inside of the pump or pipe is clogged.</li> <li>③ The inside of the pipe is clogged partly or the valve does not work correctly.</li> </ul>	<ul style="list-style-type: none"> <li>① Stop and restart the operation.</li> <li>② Repair or replace.</li> <li>③ Remove the obstacle. Replace the valve.</li> </ul>
Low capacity	<ul style="list-style-type: none"> <li>① The impeller or pump casing is extremely worn away.</li> <li>② The piping loss is much.</li> <li>③ The pump for 50Hz is operated with 60Hz.</li> </ul>	<ul style="list-style-type: none"> <li>① Repair or replace the parts.</li> <li>② Change the plan.</li> <li>③ Check the nameplate and replace the pump or impeller.</li> </ul>



## V. WARRANTY / REPAIR

### 1. Warranty

**WORLD CHEMICAL USA (“WCUSA”)  
STANDARD ONE-YEAR LIMITED WARRANTY  
FOR SALES MADE ONLY IN THE UNITED STATES, CANADA**

**This limited warranty completely replaces the warranty issued by World Chemical Co., Ltd.  
relating to the below described Pumps.**

WCUSA warrants its Magnetic Drive Pumps, Self-Priming Pumps, Oil Skimmer Systems, Vertical Pumps and Submersible Pumps (“Pumps”) against defects in materials and workmanship for one year from the date of WCUSA’s invoice to you for the affected Pump. This warranty requires you to return the Pump to WCUSA.

If there is a manufacturing defect, WCUSA will replace or repair the Pump with new or rebuilt parts at no charge to you. Please return the Pump to: World Chemical USA, [25691 Atlantic Ocean Dr. Unit B-15 Lake Forest, CA 92630](#).

When returning the Pump, include your name, address, daytime telephone number, and a description of the problem. No warranty work can be performed without this information.

Properly pack the Pump (preferably in the original carton) to prevent damage to the Pump in transit.

The repaired or replaced Pump will be warranted for a period equal to the remainder of the original one-year warranty.

All replaced Pumps, parts and components, shall become the property of WCUSA

This Limited Warranty does not cover: (a) defects or damage resulting from accident, misuse, abnormal use, abnormal conditions, improper storage, exposure to dirt, neglect, or unusual physical, electrical or electromechanical stress; (b) scratches, dents and cosmetic damage, unless caused by WCUSA; (c) Pump that has the serial number removed, defaced, damaged, altered or made illegible; (d) ordinary wear and tear; (e) defects or damage resulting from the use of Pump in conjunction or connection with other equipment not furnished or approved by WCUSA; (f) defects or damage resulting from improper testing, operation, maintenance, installation, service, caused by the use of unauthorized parts of service; (g) defects or damage resulting from external causes such as collision with an object, fire, flooding, dirt, windstorm, lightning, earthquake, exposure to weather conditions, or improper use of any electrical source; (h) irregularities or breakdowns due to chemical or hydrodynamic corrosion by liquid. We do not warrant the chemical resistance of the Pump to any chemical or to corrosion.

You will be responsible for paying for your own shipping costs for delivering the Pump to us. If we determine the Pump is covered by this warranty, we will return the new or repaired Pump to you at our expense. If we determine that the Pump is not covered by this warranty, we will return it at your expense.

WCUSA does not warrant accessory components, including, but not limited to, Impeller (including mouth ring and bushing), Rear Casing set (include shaft), O-Ring for Casing and other consumable parts.

REPLACEMENT OR REFUND OF THIS PUMP AS PROVIDED UNDER THIS LIMITED WARRANTY IS BE YOUR EXCLUSIVE REMEDY.

WE ARE NOT RESPONSIBLE OR LIABLE FOR ANY LOSS, INCONVENIENCE OR DAMAGE, WHETHER SPECIAL, DIRECT, INCIDENTAL, CONSEQUENTIAL, OR OTHERWISE, AND WHETHER KNOWN OR SHOULD HAVE BEEN KNOWN TO US, INCLUDING LOST PROFITS, GOODWILL, DAMAGE TO OR REPLACEMENT OF OTHER PUMPS AND PROPERTY AND PERSONAL INJURY RESULTING FROM ANY BREACH OF WARRANTY, THE INABILITY TO USE THE PUMP OR UNDER ANY LEGAL THEORY IN CONTRACT OR TORT. THESE WARRANTIES AND REMEDIES ARE YOUR SOLE AND EXCLUSIVE WARRANTIES AND REMEDIES IN CONNECTION WITH THE SALE AND USE OF THE PUMP. NO OTHER WARRANTIES, ORAL OR WRITTEN, EXPRESS OR IMPLIED, ARE GIVEN. OUR LIABILITY IS LIMITED TO THE ACTUAL PURCHASE PRICE YOU PAID TO THE RETAIL SELLER OF THE DEFECTIVE PUMP. EXCEPT TO THE EXTENT PROHIBITED BY LAW, ANY IMPLIED WARRANTIES OR CONDITIONS OF MERCHANTABILITY AND FITNESS FOR A PARTICULAR PURPOSE ARE LIMITED IN DURATION TO THE DURATION OF THIS LIMITED WARRANTY.

Some states do not allow the exclusion or limitation of implied warranties or liability for incidental or consequential damages, or do not allow a limitation on how long an implied warranty lasts, so the above limitations or exclusions may not apply to you. You are advised to contact applicable state laws for a full determination of your rights. This warranty gives you specific legal rights, and you may have other rights which vary from state to state.

No dealer, agent or employee is authorized to make any modification, extension, change or amendment to this warranty. This warranty may not be assigned without the prior expenses written approval of WCUSA.

## 2. Repair

**Notice:**

For repair, consult the supplier. When returning a pump, thoroughly clean and pack the wet parts kit.

If irregularities are detected during operation, stop the operation immediately for check. (Refer to the section on “troubleshooting”).

- (1) Consult your supplier or us for repair.
- (2) Read this manual again and re-check before requesting repair.
- (3) When visiting to a distance location for repair, the travel expenses are charged.
- (4) Inform the followings when requesting repair.
  - Model name and serial number
  - Use duration and condition
  - Damages parts and condition
  - Liquid (Name, Specific gravity, Temperature, Slurry)

If liquid leaks during transportation, it is very dangerous, so make sure to clean inside thoroughly. When ordering replaced parts, specify the name in the parts name list (P7, 9, 10).

Although, inform the parts' number and material, too.

**Installation record**

Model:	
Purchase date:	Serial number:
Start date:	Supplier:



## **WORLD CHEMICAL CO., LTD. / Japan**

### **Head Office / Overseas department**

3F, 1-1-14, Taito. Taito-ku, Tokyo, 110-0016 Japan

TEL 81-3-5818-5130 FAX 81-3-5818-5131 (Head office)

TEL 81-3-5818-5131 FAX 81-3-5818-5131(Overseas department)

### **Osaka Office**

3F, 1-19-25, Edobori, Nishi-ku, Osaka-shi, Osaka, 550-0002 Japan

TEL 81-6-6467-8565 FAX 81-6-6467-8566

### **Nagoya Office**

9F, 1-11-20, Nishiki, Naka-ku, Nagoya-shi,

Aichi, 460-0003 Japan

TEL 81-52-253-8426 FAX 81-52-253-8436

### **Fukuoka Office**

5F, 2-17-19, Hakataekimae, Hakata-ku, Fukuoka-shi, Fukuoka,  
812-0011 Japan

TEL 81-92-710-6001 FAX 81-92-710-6125

### **Tsukuba Factory**

6127-5, Onogo-machi, Joso-shi, Ibaraki, 300-2521 Japan

TEL 81-297-24-1071 FAX 81-297-24-1075

## **WORCHEMI TAIWAN CO., LTD. / Taichung, Taiwan**

No.915, Zhongshan Rd., Shengang Dist., Taichung City 42955, TAIWAN

TEL 886-4-2562-8358 FAX 886-4-2562-8351

## **WORLD CHEMICAL USA, INC. / California, U.S.A.**

25691 Atlantic Ocean Dr. Unit B-15 Lake Forest, CA 92630, U.S.A.

TEL 1-949-462-0900 FAX 1-888-860-3364

## **SUZHOU WORLD TECHNOLOGY CO., LTD. / Jiangsu, China**

61, Fu Yuan Road, Xiang Cheng Economic District, Suzhou, Jiangsu Province, China

TEL 86-0512-6579-8212 FAX 86-0512-6579-8215